



OAS | CICAD

**INTER-AMERICAN DRUG ABUSE
CONTROL COMMISSION
CICAD**

Secretariat for Multidimensional Security

**SIXTY-FIFTH REGULAR SESSION OF CICAD
May 8 - 10, 2019
Buenos Aires, Argentina**

**OEA/Ser.L/XIV.1.65
CICAD/doc.2471/19
8 May 2019
Original: Español**

SPECIAL ASSETS CORPORATION



**El emprendimiento
es de todos**

Minhacienda



Sociedad de Activos Especiales S.A.S.

Who are we?

We are a unique mixed-economy company chartered by law and operating under private law, the purpose of which is to **administer special assets** that are in the process of being forfeited or that have been declared forfeited.



Law 1708 of 2014 and Law 1849 of 2017

Authorize us as administrators of **FRISCO**.

FRISCO: Fund for Rehabilitation, Social Investment, and Fight against Organized Crime

This is a special account, without legal personality, the goal of which is to strengthen the justice sector, social investment, drug policy, rural development, care of and compensation for victims of illicit activities, by means of the administration and transfer of ownership of assets and resources to the National Government.

CORPORATE GOVERNANCE

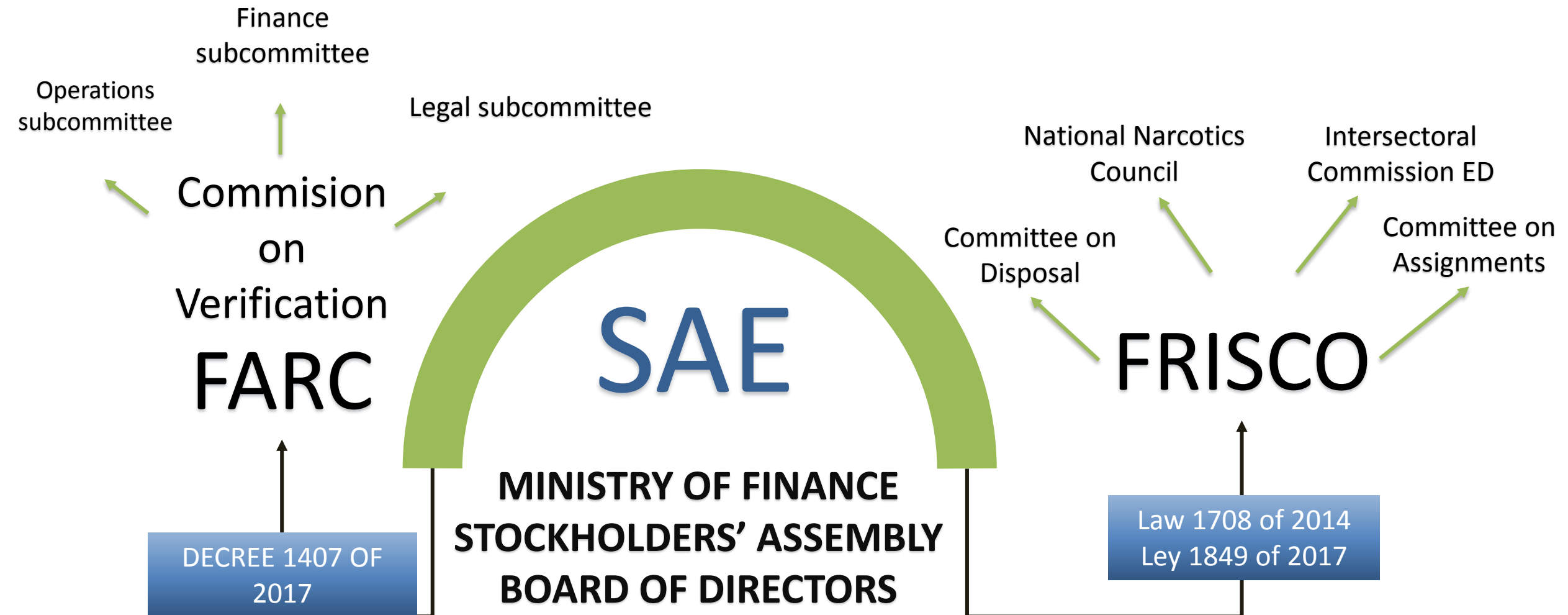



ORGANIZATION CHART

Staff	387
Apprentices	17

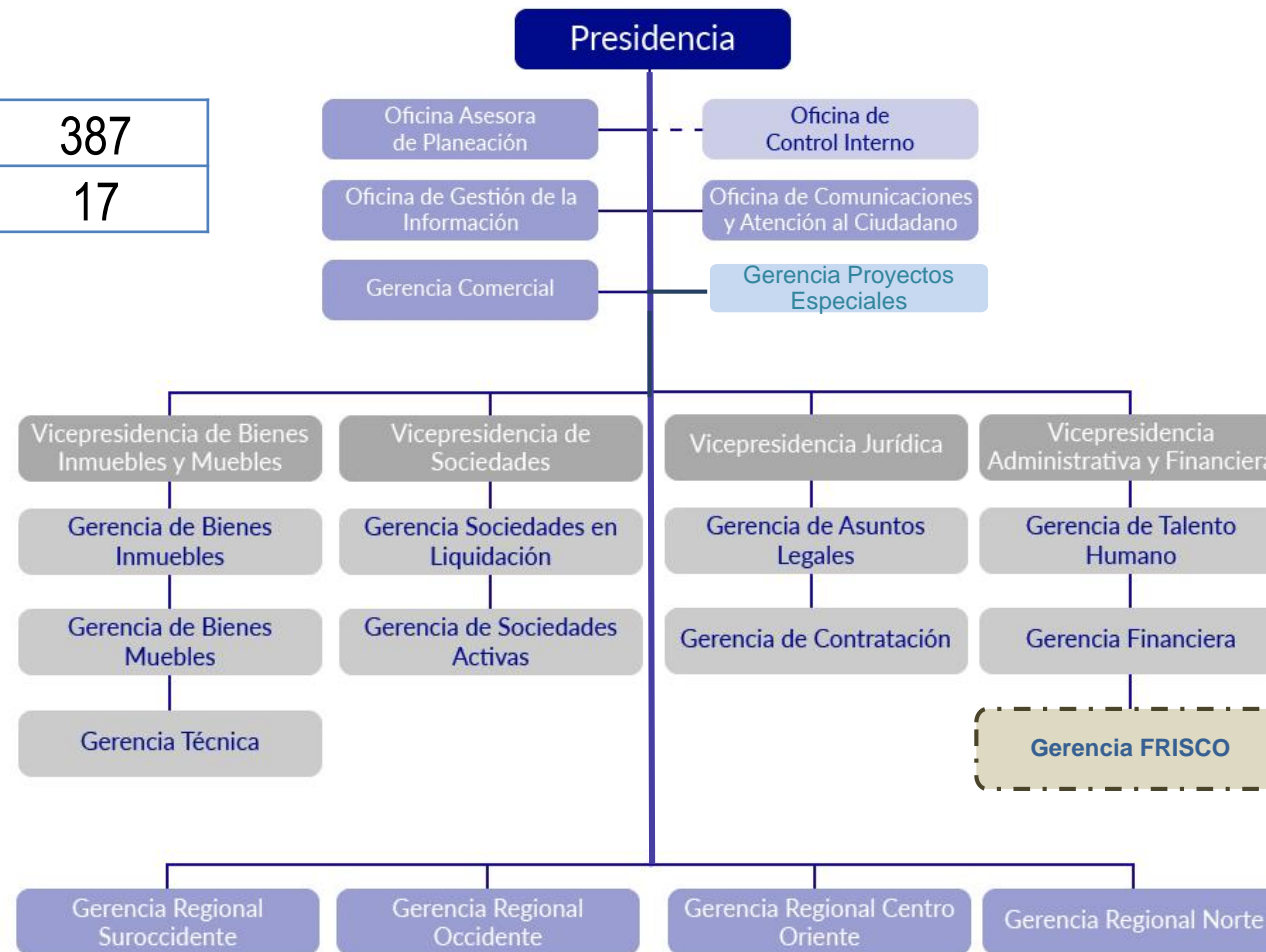



How do we do it?

Corporate architecture...

Corporate architecture- Mission statements

CAPA DE PROCESOS MISIONALES

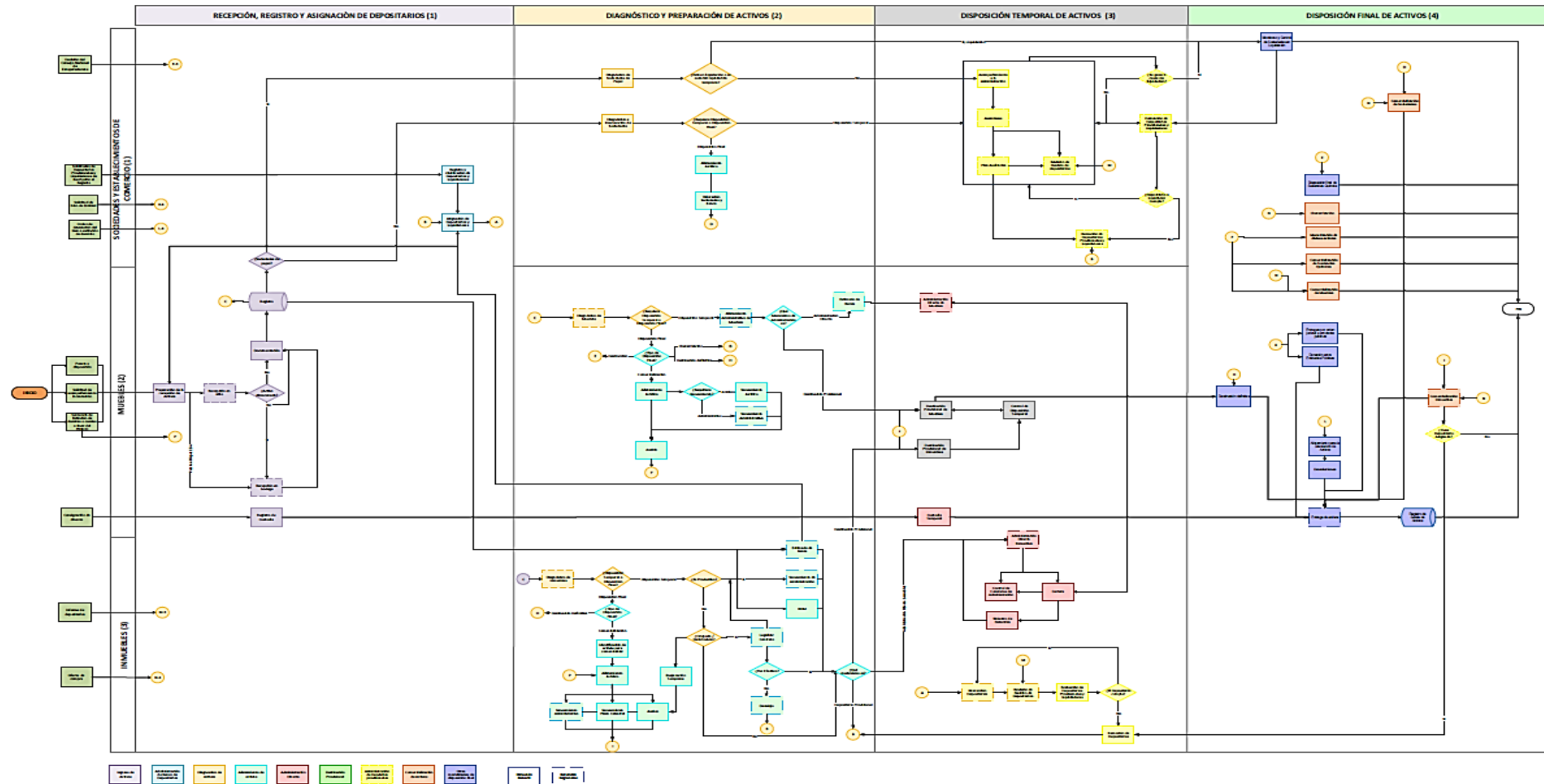

ZOOM DE ARQUITECTURA - INTERACCION CON ACTORES DEL MACROPROCESO

Investigación proceso de Extinción de Dominio

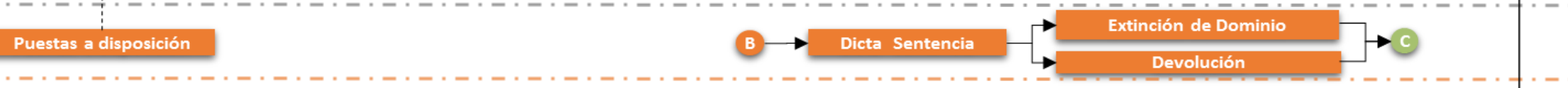
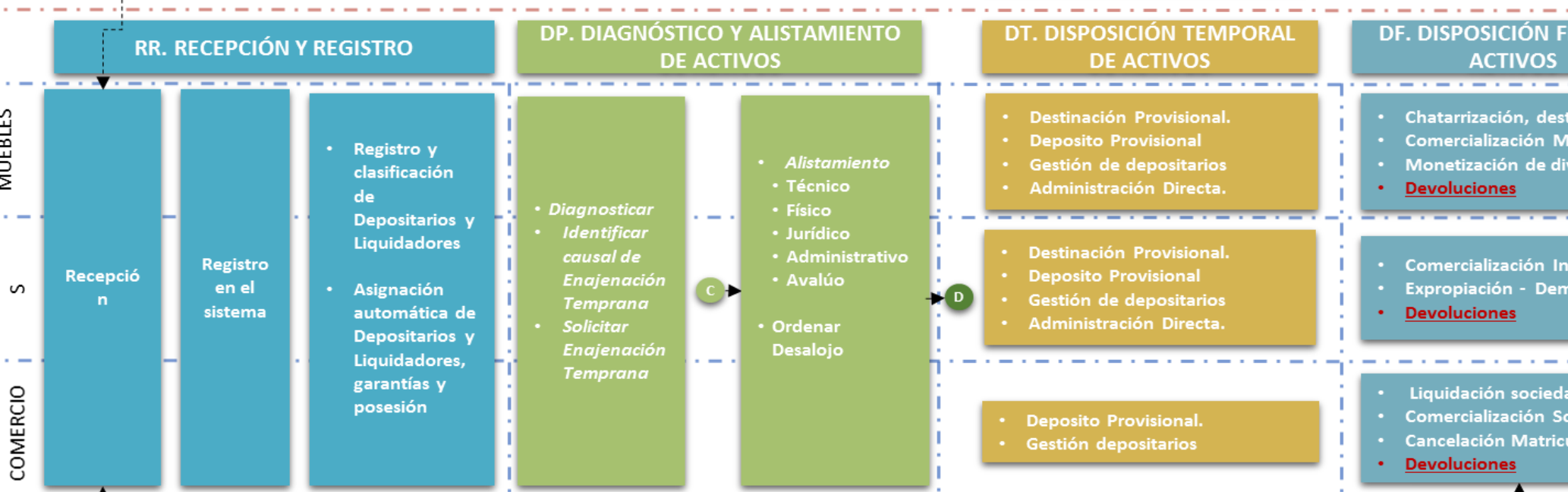
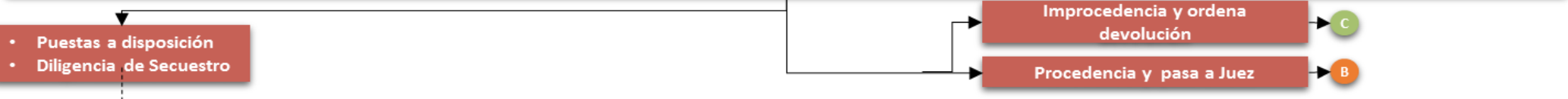

- GESTIÓN FGN
- GESTIÓN SAE
- MIN JUSTICIA
- COMITÉ TRIPARTITO
- RAMA JUDICIAL
- CISA
- AFECTADO

FRISCO

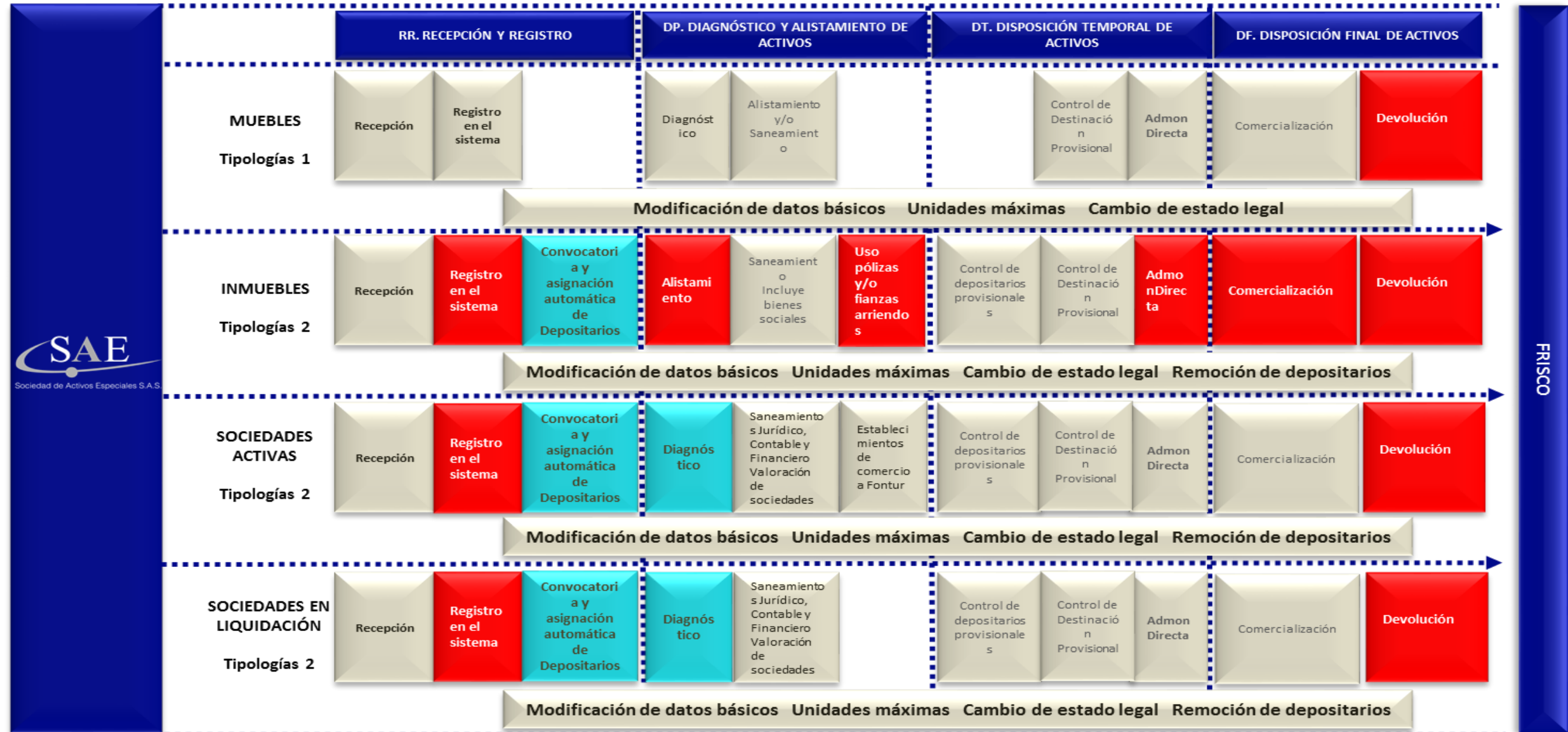

FRISCO

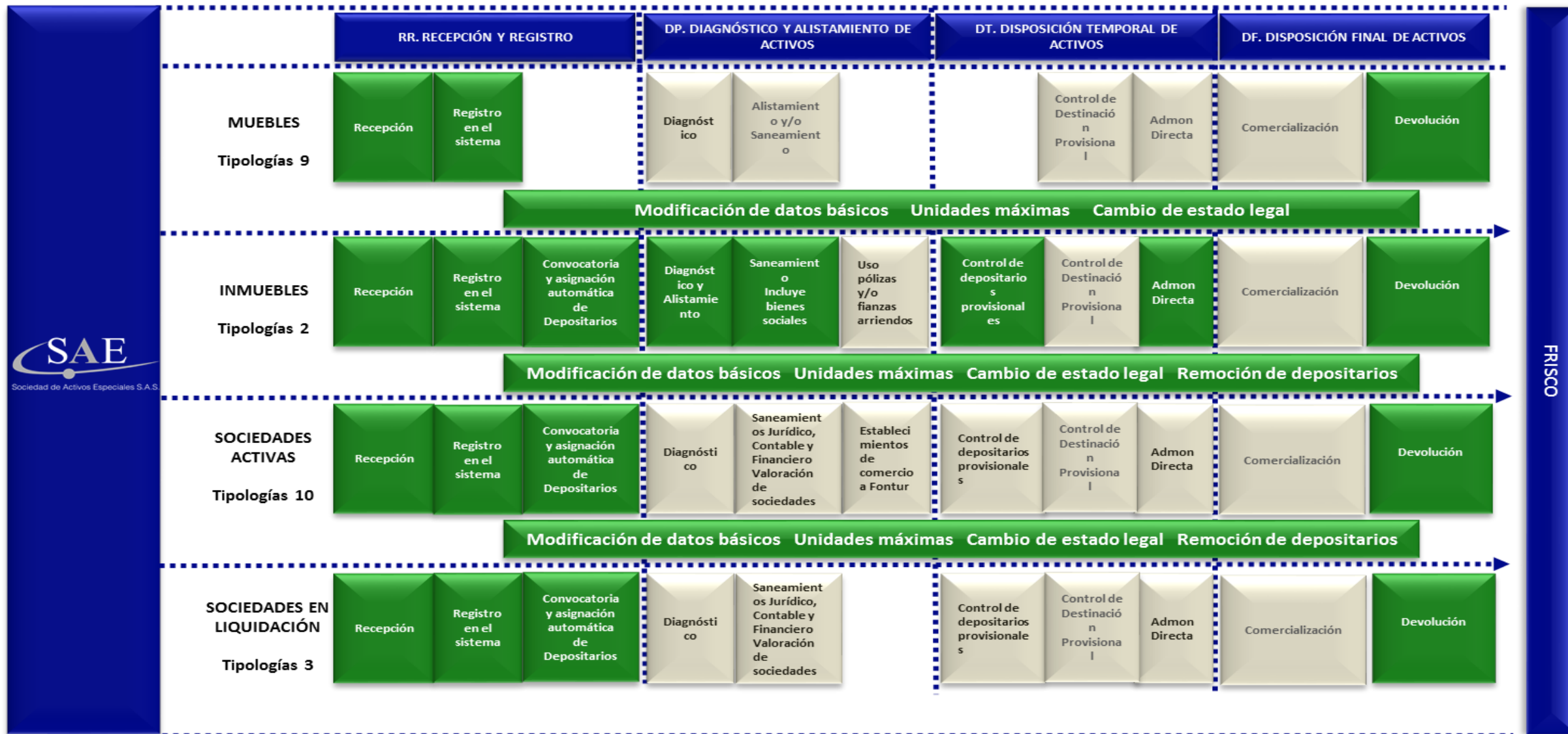



REGULATORY CHANGES

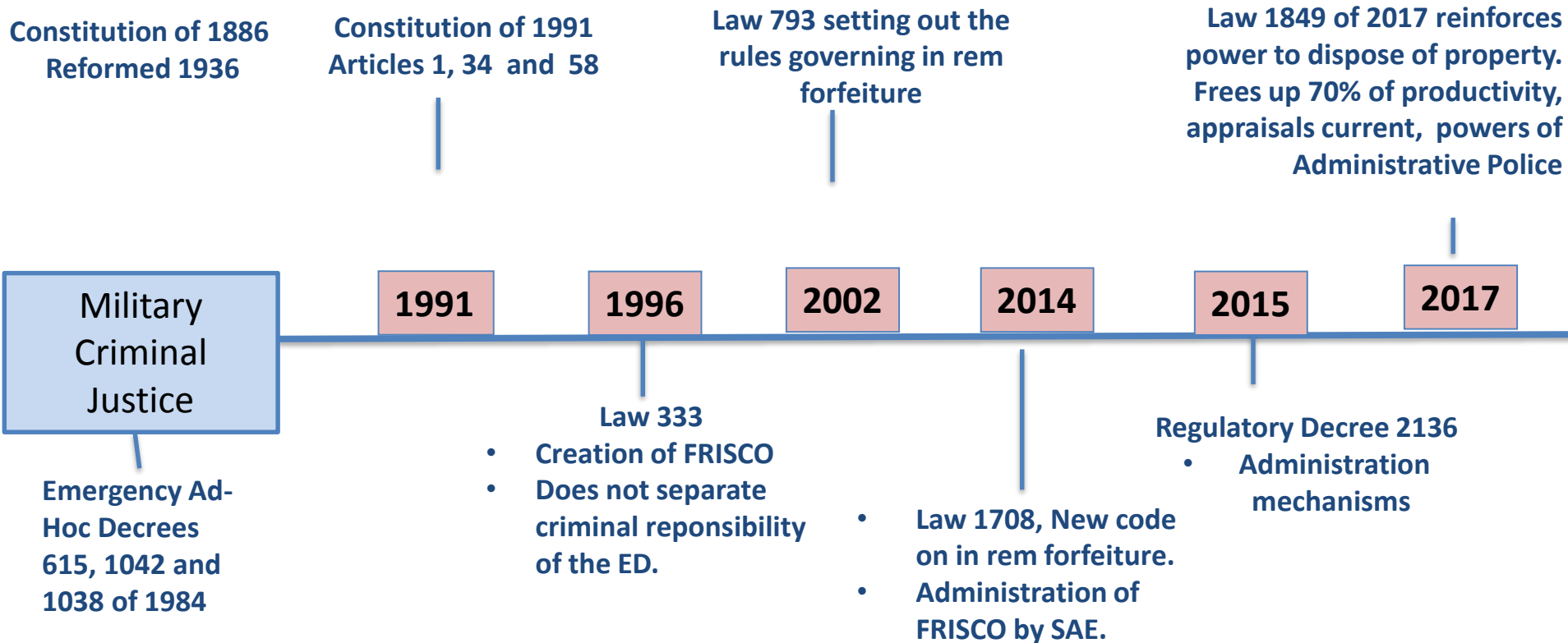



WHAT WE ADMINISTER

Classification of special assets

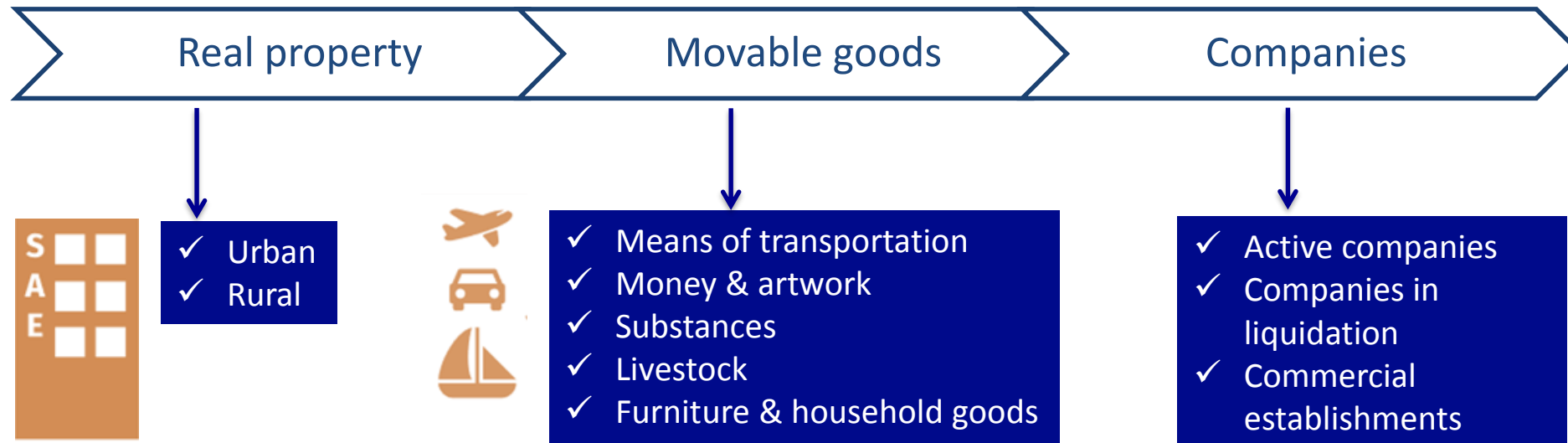

Lo que administramos

¿Cuántos Inmuebles?



21.785

Bienes inmuebles no sociales administrados por SAE S.A.S.



2.927

Extintos

Rurales 1.123
Urbanos 1.803



18.858

En Proceso

Rurales 5.360
Urbanos 13.560

¿Cuántas Sociedades y establecimientos de comercio?

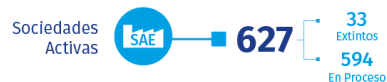

■ Gerencia de Sociedades Activas ■ Gerencia de Sociedades en Liquidación

Fuente: Aseguramiento de la información
Febrero de 2019

¿Cuántos Muebles?

Medios de Transporte



455

Extintos

4.534

En proceso

Dinero



31 Extintos
734 En Proceso

Piezas de Arte



868

730 Extintos 138 En Proceso

Muebles, enseres y joyas



37.110

912 Extintos 36.198 En Proceso

Animales



3.096

Semovientes

Sustancias



537

0 Extinto 537 En Proceso

Valor de los Activos
2018
aproximadamente

Inmuebles No Sociales
Total:
U\$ 900 millones

Valor patrimonial

Sociedades Activas: **U\$ 600 millones**

Sociedades en Liquidación: **U\$ 300 millones**

*Corte a 31 de diciembre de 2017

Muebles

Medios de transporte no sociales
U\$10 millones

Assets Received Law 1708

REAL PROPERTY NO SOCIALES



4,644 Real
property

COMPANIES & ESTABLISHMENTS

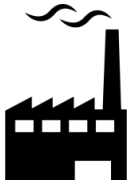

523
Companies &
Establishments

MOVABLES



9,754
Movables

Judgments under Forfeiture Law 1708

NON-CORPORATE REAL PROPERTY 326 Real property*

COMPANIES & ESTABLISHMENTS 19 Companies

MOVABLES 74 Vehicles

*judgment anticipated, 227 real property

Judgments for Return (of property) Law 1708

REAL PROPERTY NO SOCIALES 63 Real Property

COMPANIES & ESTABLISHMENTS 3 Companies

MOVABLES 68 Movables

Processing Time, In Rem Forfeiture

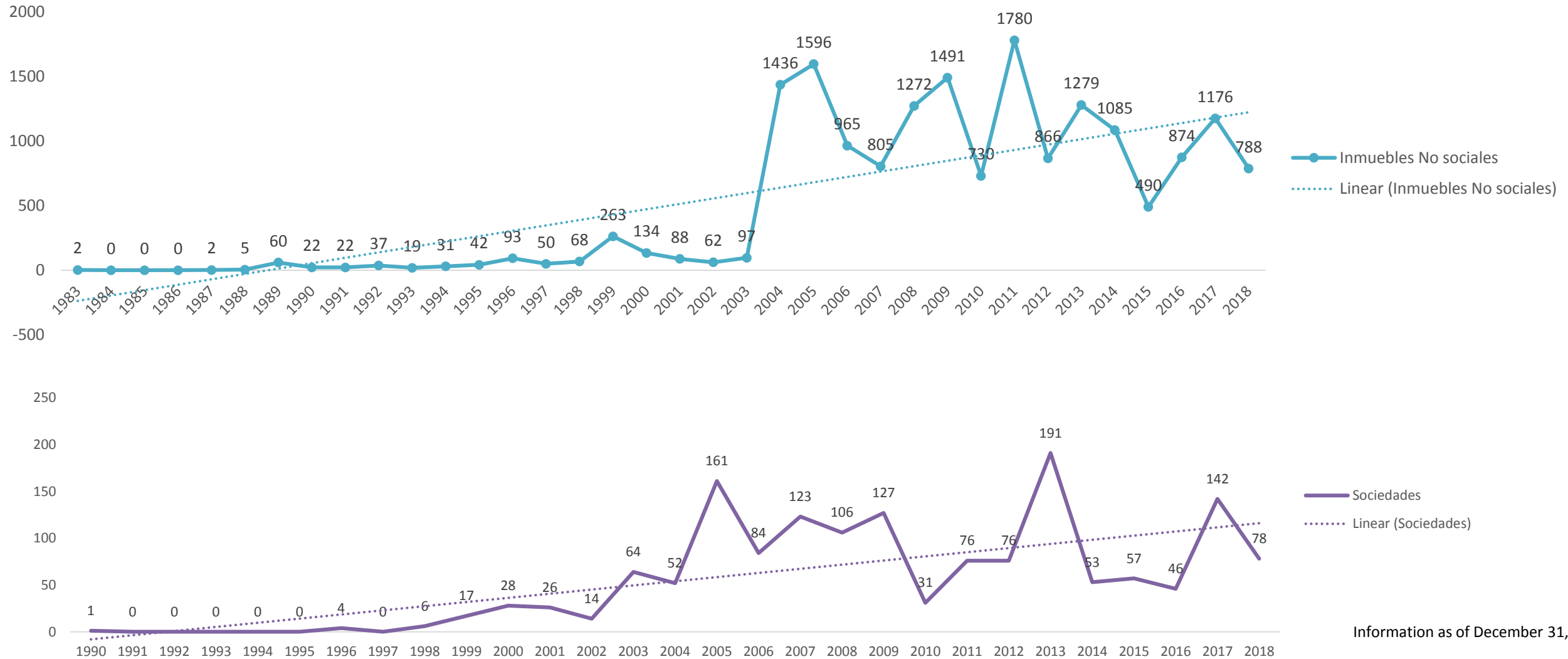

Information as of December 31, 2018

Processing Time, In Rem Forfeiture

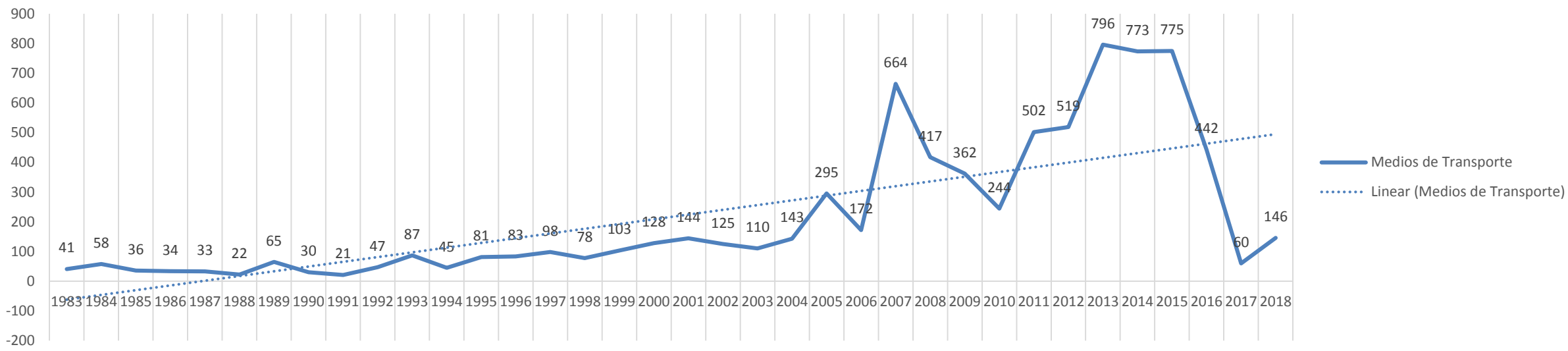

IN REM FORFEITURE PROCESS



Information as of December 31, 20

Makeup of the Inventory

NON-CORPORATE REAL PROPERTY



FORFEITED 13%

IN PROCESS 87%

US\$1,100

COMPANIES & ESTABLISHMENTS

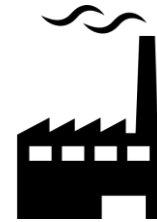

FORFEITED 16%

IN PROCESS 84%

On Paper 46%

US\$1,400

MOVABLES



FORFEITED 5%

IN PROCESS 95%

US\$750

INDIVIDUAL
COSTS
(Per year)

SEIZURE PROCEEDINGS: PERFORMANCE



El emprendimiento
es de todos

Minhacienda

ASSETS REALIZED PER YEAR

Proceedings vs Assets in process

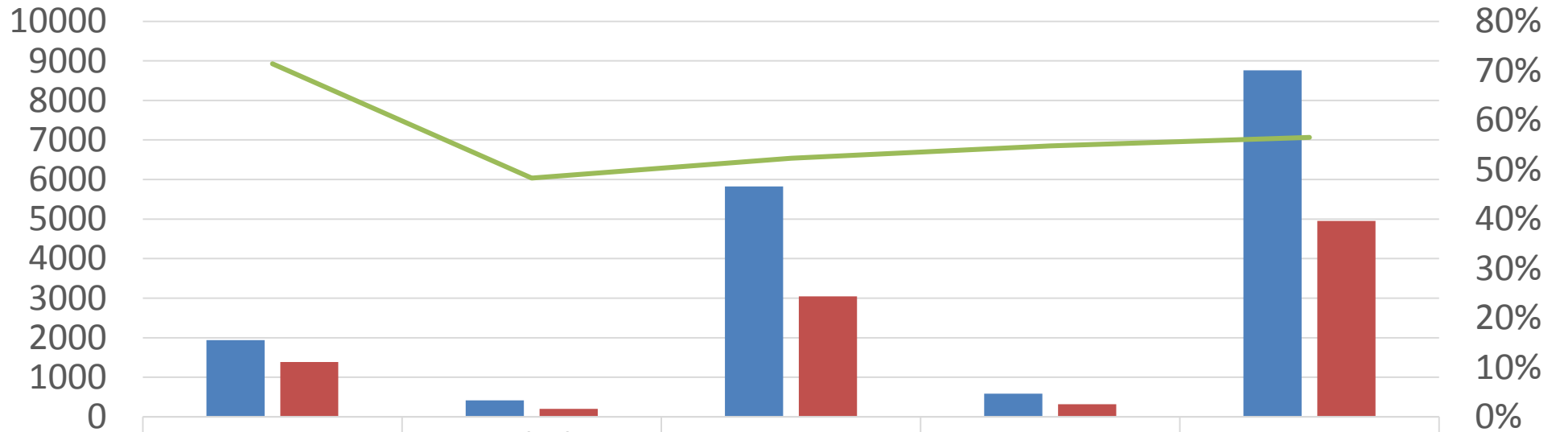

Bienes en Resolución	1941	412	5823	584	8760
Bienes Materializados	1386	199	3046	320	4951
Porcentaje	71%	48%	52%	55%	57%

Bienes en Resolución Bienes Materializados Porcentaje

ILLEGAL OCCUPATION OF REAL PROPERTY



El emprendimiento
es de todos

Minhacienda

Management of evictions, inventory received by DNE

2014

Inventory received
by DNE
19,819

INITIAL STATUS OF OCCUPATION

- Ocupados Ilegalmente
- Arrendados
- Desocupados
- En destinación provisional
- Otros Estados
- No susceptibles de Estado de Ocupación

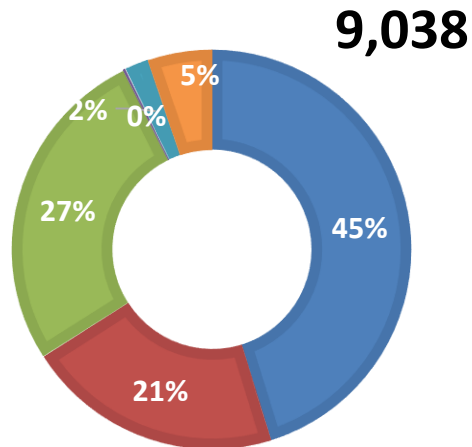

Legalized 161

Recovered 807



Decision issued 5,065

Being rehabilitated 1,009

In process 394

82% Processed
7,436

Seizure Proceedings
4,107 Marked for seizure

2019

Inventory received
by DNE under
management by SAE
16,628

CURRENT STATUS OF OCCUPATION

- Ocupados Ilegalmente
- Desocupado
- Arrendado
- En destinación provisional
- Otros Estados
- Arrendado en Saneamiento

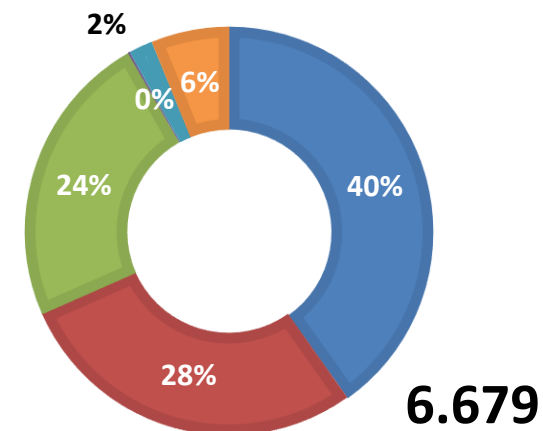

Management of evictions, inventory received by DNE

2014 - 2019

Inventory received
by FGN
5,140

INITIAL STATUS OF OCCUPATION

- Ocupados Ilegalmente
- Arrendados
- Desocupados
- Otros Estados

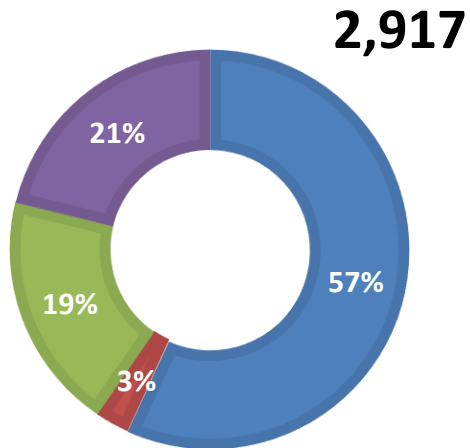

Legalized 71
Recovered 401



Decision issued 1,422
Being rehabilitated 208
In process 96

62% Processed
2,198

Seizure proceedings
894 Marked for seizure

2019

Current inventory
received by FGN
5,083

CURRENT STATUS OF OCCUPATION

- ARRENDADO
- ARRENDADO EN SANEAMIENTO
- DESOCUPADO
- OCUPADO ILEGAL
- OTROS ESTADOS

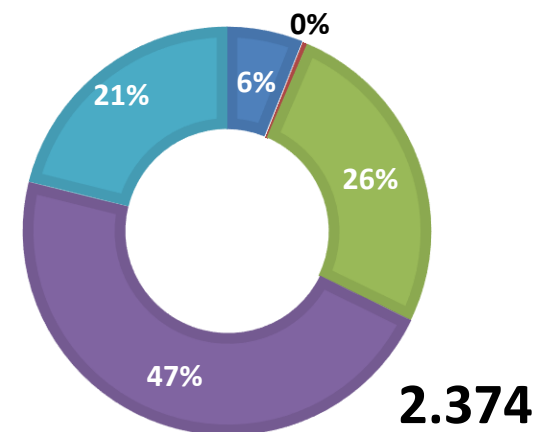

ASSETS FOR PRODUCTIVITY



El emprendimiento
es de todos

Minhacienda

Disposal of Assets and Resources of FRISCO

Art. 22 of Law 1849/18

1

GRADUAL,
PROGRESSIVE
PAYMENT
LIABILITIES OF FRISCO

FRISCO

2

RESOURCES NEEDED FOR
OPERATIONS OF THE
ADMINISTRATOR



3

DISPOSALS UNDER THE LAW



4

PERCENTAGE BALANCES



Rural farmland is excluded from these percentages, after effecting disposals called for in paragraph 1.1.1 of the Final Accord to terminate the conflict and build a stable and lasting peace.



Sept. 30, 14 – Jan. 31, 19

ACTUAL COLLECTIONS

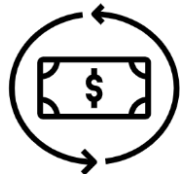

US\$40,000,000

Foreign exchange



293

US\$43,000,000

Real property



265

US\$1,000,000

Direct sales

US\$84,000,000

COLLECTION IN PROCESS



102

Real property

US\$13,000,000

FOR SALE CISA



605

Real property

US\$103,000,000

OTHER PROCEEDINGS



#261 Forfeited

#124 Criminal

Scrap metal

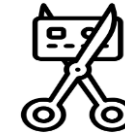

#33,652 No proceedings

Destruction of movable property



313

Destruction of substances

Frisco Inventory Subject to Early Forfeiture



12,977

Urban buildings

\$2.4 billion

See Land registers

4,527

Means of transportation

43%

1,976 Criminal

47%

1,200 Scrap metal

10%

1,351 Marketable

\$10,000

See Reference

72,027

Grams of gold

\$4,858

See Commercial

2,127

Livestock (Cattle)

\$2,127

See Commercial

Note: These values do not include companies administered by FRISCO

Assets for productivity



Transfers of liquid assets to the Nation	US\$90,000,000
Transfers of physical assets to the Nation	US\$35,000,000
Receipts for rental of assets	US\$10,000,000
Real property legalized	US\$1,000,000
Sales of real property	US\$57,000,000
Monetization of foreign exchange	US\$69,000,000
Receipts from cattle auction	US\$2,000,000
Sale of companies and social assets	US\$4,500,000
Sale of portfolio	US\$67,000,000

Transfers made during the period 2015-2019



DISPOSALS AND TRANSFERS OF LIQUID ASSETS

	MINJUSTICIA -----	US\$11,000,000
	RAMA JUDICIAL -----	US\$19,000,000
	Gobernación del Archipiélago de San Andrés, Providencia y Santa Catalina -----	US\$10,000,000
	PRESIDENCIA DE LA REPÚBLICA -----	US\$22,000,000
	POLICIA NACIONAL -----	US\$9,000,000
	FISCALÍA GENERAL DE LA NACIÓN DE LA GENTE, POR LA GENTE, PARA LA GENTE -----	US\$14,000,000
	UNIDAD PARA LAS VÍCTIMAS -----	US\$2,000,000
	MINSALUD -----	US\$1,000,000

DISPOSALS IN KIND

	Agencia Nacional de Tierras JUNTOS ABRIMOS LAS PUERTAS AL PROGRESO -----	US\$14,000,000
	Gobernación del Archipiélago de San Andrés, Providencia y Santa Catalina -----	US\$13,000,000
	PRESIDENCIA DE LA REPÚBLICA -----	US\$1,000,000
	FISCALÍA GENERAL DE LA NACIÓN DE LA GENTE, POR LA GENTE, PARA LA GENTE -----	US\$2,000,000
	UNIDAD DE RESTITUCIÓN DE TIERRAS -----	US\$908,000
	POLICIA NACIONAL -----	US\$13,000

Company's performance compared to the sector and/or other comparables

Order	Business name	Payments
1	ECOPETROL	\$1,619,123,013,365.00
2	Banco Agrario de Colombia S.A	\$180,318,182,463.00
3	Interconexión Eléctrica S.A Isa	\$154,327,706,031.00
4	SAE	\$94,399,339,659.00
5	La Previsora S.A Compañía De Seguros	\$22,734,195,590.00
6	Banco de Comercio Exterior de Colombia S.A	\$6,282,373,756.00
7	Centro De Inversiones S.A	\$5,804,398,457.00
8	CEDENAR	\$3,165,778,610.00
Total		\$2,086,154,987,931.00



Disposals in 2018

Disposals and transfers of liquid assets	
Ministry of Justice	11,000
Fund for victim compensation	1,967
Government of San Andrés Islands	18,931
Office of the Public Prosecutor of the Nation	12,446
Judiciary	12,446
Judicial Police	4,978
National Government	19,913
Total	81,681
Disposals in kind	
Office of the Public Prosecutor	8,846
Presidency of the Republic	3,872
Total	12,718

*In millions

Source: Author's own; information taken from the financial statements of November 2018 Ministry of Finance



THANK YOU